

Installation Instructions

Pre-Finished Engineered Bamboo

Essence | Neotera
Tongue & Groove System



 **Teragren**®

FINE BAMBOO FLOORING, PANELS & VENEER

Teragren T & G - Hardwood Core Engineered

Essence: Engineered Wide Plank Xcora® Strand Bamboo Flooring. 14mm (.55") thick x 7.48" wide x 72.83" long. 3mm strand woven bamboo top wear layer. 7 ply cross engineered, including wear layer. Rapid growth hardwood plywood core.

Neotera: Engineered Wide Plank Xcora® Strand Bamboo Flooring. 12mm (.47") thick x 5.12" wide x 72.83" long. 2mm wear strand woven bamboo top wear layer. 7 ply cross engineered, including wear layer. Rapid growth hardwood plywood core.

Attention

Before starting installation, read all instructions thoroughly. Should any questions arise, please contact the local Teragren dealer or phone Teragren Bamboo direct at 800-929-6333. Instructions available at info@teragren.com. All installation instructions must be followed for warranties to be considered valid. Pre-inspect the job site prior to delivery of the floor to ensure the structure is suitable for hardwood flooring installation using the following guidelines.

Owner/Installer Responsibility

1. Inspect all materials carefully prior to installation. Warranties do not cover materials with visible defects once they are installed. Installation constitutes acceptance.
2. Inspect the bamboo flooring in well lighted conditions to ensure proper identification of any potential problems. Carefully inspect the flooring for grade, (see Teragren Bamboo grading standards at teragren.com) for color, finish, and quality. If the flooring is not acceptable, contact your Teragren retailer and arrange shipment of replacement material. Defective product will be replaced. Material that is subjectively viewed as unacceptable but falls within Teragren's grading norms will not be replaced.
3. Prior to installation of any flooring, the installer must ensure the job site and sub-floor conditions meet the requirements specified in these instructions.
4. Bamboo flooring installation should be one of the last items completed on the construction project. Limit foot traffic on the finished bamboo floor.

Grading Standards

General Rules:

Bamboo flooring shall be tongue and grooved and end matched, unless otherwise indicated. Flooring shall not be considered of standard grade unless properly dried. The drying standard for Teragren Bamboo shall be 7 to 9% moisture content by volume with a plus or minus factor of 2% for storage conditions in various climate zones.

Grading Rules:

Teragren Bamboo floors are not graded in the same way as hardwood flooring. Bamboo has many similarities to wood but different grading standards are applied.

The main stem of a bamboo is called a culm. The culm is the support structure for the branches and leaves, and contains the main vascular system for the transport of water, nutrients and food. Culms also serve as food storage organs. The culm is made up of jointed segments, the joints are defined as nodes by the bamboo industry.

Teragren uses Moso Optimum 5.5 bamboo for the manufacture of its products. We only use the choicest section at the bottom of the culm and segment the raw material into slats or further process into strands. Teragren only harvest the culms when they reach full maturity and hardness. Culms can reach their full size and height in one year, but do not fully mature to their most stable and hardness potential until they are at the peak of age at between 5 ½ and 6 years of age.

The nodes appear randomly throughout the plank, much like small closed knot's would in a wood floor. This is a natural characteristic of the plank.

Strand Woven: The strands are created from slats that are randomly split into narrower slats and then woven through each other. The nodes that appear are more random and less noticeable than in flat grain bamboo.

NOTE: The appearance of nodes is an inherent natural characteristic of the product, and not considered to be a manufacturing defect.

Teragren grading rules allow for filled holes, mineral streak, open checks, tight checks, and filled checks. Bird peck, pin worm hole, and beetle hole are acceptable (any insects are killed with Borate solution and in the drying process)

Environmental Issues

Damage caused by inappropriate handling, environment, installation, or maintenance issues will not be considered in relationship to grade.

Storage and Handling

Handle and unload bamboo flooring with care. Store in a dry place; Make sure to provide at least a four-inch space (using dry 4" x 4" stickers or a dry pallet that provides enough clearance under boxes for proper air movement. Do not stack Teragren boxes directly on the subfloor when storing on jobsite or during acclimation process.

Prior to delivery of bamboo flooring, outside doors and windows must be in place. All concrete, masonry, plastering, and other "wet" work must be complete and thoroughly dry prior to flooring installation. Roofing and the exterior shell of the structure must be finished and weather tight with doors and windows installed. The wall coverings should be in place and all painting completed—except for the final coat on the base molding. Room temperature and humidity should be consistent with year round conditions for at least one week prior to installation. When possible, install base molding after floor installation is complete.

HVAC MUST BE RUNNING WITH A ROOM TEMPERATURE OF BETWEEN 60°F TO 80°F AND RELATIVE HUMIDITY OF BETWEEN 35 AND 55%, maintained and constant during installation process and throughout life of the floor.

Pre-Installation Inspection

VISUAL INSPECTION

The first inspection is visual and basic. Is there water in the building? Are the doors and windows installed and the building weather tight?

CLIMATE CONTROL

If heating and/or air conditioning with proper humidity controls are in operating condition, they need to be turned on. If it is not possible for the permanent system to operate, a temporary system that provides proper temperature and humidity conditions must be in place and remain in place until permanent climate control is operational.

INSTALL FLOORING LAST

Bamboo floor should be the last trade in the house (before base boards are installed). All concrete, masonry, plastering/drywall, texturing, and painting/primer coats should be completed beforehand. Covering the floor while wet trades are in the house

can lead to moisture condensation on the protective paper. Moisture can pull into the paper or be trapped under the surface of materials used to cover the floor. Paper coverings also allow dents and scratching to occur. Coverings held in place for more than 24 hours by blue tape can damage the floor. The adhesive in tapes contain Phthalates /plasticizers that have the ability to penetrate floor finishes and bond with the finish at the molecular level presenting a risk of pulling/damaging the finish when the tape is removed. Teragren recommends that built in cabinets and built in furniture be installed before installation of the floor. This prevents damage to the flooring, making any potential flooring repairs simpler to perform.

Exterior Checks

1. Is exterior soil elevation 6" below edge of flashing?
2. Does exterior slope away from foundation at a rate of 6" drop in 10' for soft landscaped areas and 3" drop in 10' for hard-paved areas?

NOTE: Proper drainage away from the structure is absolutely critical to ensure weather-tight conditions and crucial to proper hardwood flooring performance. If structure is near a hill, the lot should be graded with a swale to move moisture off the lot and prevent it from coming in contact with the foundation.

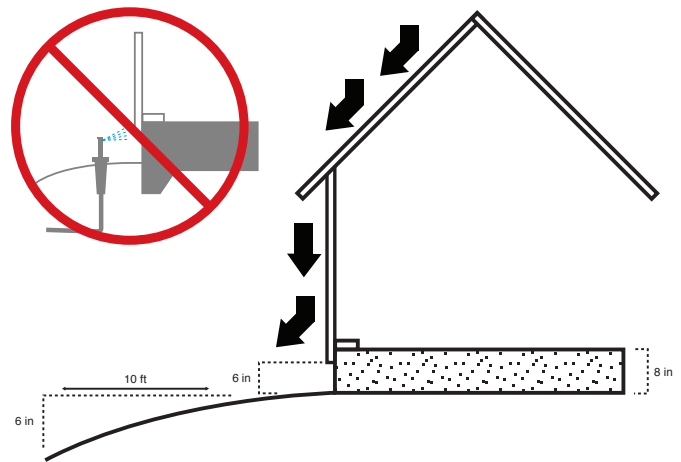

Crawl Space Ventilation

Crawl space earth (or thin concrete slab) should be covered 100% by a vapor retarder of black polyethylene (minimum 6 mil) or any recommended puncture resistant membrane, such as Class C meeting ASTM D1745. Check local codes for any additional requirements. Size of available vents should equal to 1.5% of the square footage within the crawl space. Relative humidity should be consistent with interior of home. Moisture content of sub floor should not vary more than a 2% MC from the top of the sub floor to the bottom.

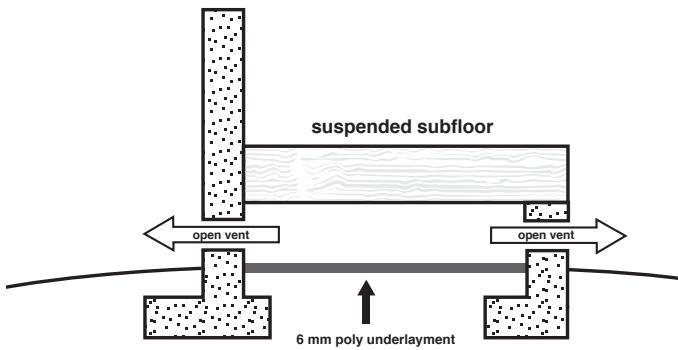

It may be necessary to install temperature/humidity activated exhaust fans to create more air movement in the crawl space. Uncontrolled humidity and moisture in crawl space will lead to mold and damage to the structure, as well as the bamboo floor. In these events, a contractor specializing in dehumidifying systems will need to be contracted to keep crawlspace humidity within proper norms. This is more likely in high humidity areas. Ensure that clothes driers are properly vented to the outside of the foundation. Check for signs of plumbing, both pressurized and non-pressurized/drain leaks.



NOTE: Completely sealed crawlspaces (no exterior cross-ventilation) require a dehumidification system as part of the sealed crawlspace design.

Basement Moisture & Humidity Control

Basements should be completely weather tight and have proper drainage away from the foundation walls in place to ensure that the basement remains dry.

1. Rain gutters must be in place to carry moisture away from the house. French drains are recommended, and basement walls should be properly sealed.
2. Relative humidity of basements should not be more than 10% higher than the upper floors.

3. Humidity control of the basement is vital to help control mold and prevent damage to the structure and bamboo flooring.

4. Basement walls should be inspected for cracks and excessive moisture content.

5. Drains must be placed at basement windows.

6. Direct sprinklers and irrigation systems away from the foundation. Sprinklers spraying the foundation edge can lead to moisture intrusion into structure. Drip irrigation systems for plant beds is recommended.

EQUILIBRIUM MOISTURE CONTENT

The moisture content of Bamboo and Wood fiber saturation point is a function of both relative humidity and temperature in the surrounding air. When Bamboo and Wood is neither gaining nor losing moisture, and equilibrium moisture content (EMC) has been reached.

Wood technologists have graphs that precisely tie EMC and humidity together, but as a general rule, a relative humidity of 25% would be approximately have an EMC of 5%, and a relative humidity of 75% would have an EMC of approximately 14%EMC.

A 50% swing in relative humidity produces an EMC change of approximately 10%. How that effects Wood and Bamboo flooring varies somewhat by species. However, this change in EMC will create a dimensional change in the material itself, and lead to structural damage.

Teragren manufactures material to mimic what would be found in the middle of a 35–55% relative humidity environment (roughly 40% RH). Consequently, it is pre-acclimated to the green zone conditions found in the chart below.

EMC Further Explained:

Example: Structure is maintained at a temperature of 70°F maintained and current relativity is 40%RH
The combined temperature of 70°F and 40%RH – Sustained and constant conditions would produce an EMC 7.7% This value is represented in the green shaded area in the chart below.

EMC - Geographic Map of the Continental United States
NWFA map. Source: The US Department of Agriculture Forest Products Laboratory.

Each region has an EMC readings both high and low. This represents a seasonal swing in moisture content. Where the EMC readings are below 6.8% humidity control must be added to maintain structural integrity of floor in the dryer months. Humidification systems make heating more efficient and are conducive to enhanced human respiratory health.

The EMC range per region indicated, pertains to all

wood and bamboo species.

Each region indicates the EMC for both January (the first number) and July (the second number)

In regions where the moisture content of the material would exceed 10% EMC, HVAC systems must remove some of the humidity for optimum performance. Most air conditioning units dehumidify as part of the cooling process. Additional/supplemental dehumidification systems can make the HVAC system more efficient and cost effective to run.

NOTE: Actual EMC may differ significantly from the numbers indicated on the geographic map (upper right). The NWFA indicates that the map can not be used as a basis for installation. However, it is made available so differences in EMC and the effects of EMC change can be better understood.

From - United States Department of Agriculture
Forest Products Laboratory
National Wood Flooring Association

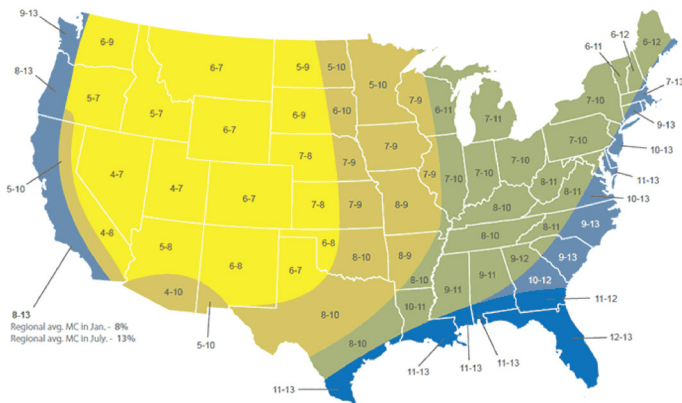

Acclimation of Engineered Bamboo

The pre-installation inspection of the floor is to be completed prior to the beginning of the acclimation process. Open 2 to 3 boxes to ensure it is what was expected. Test fit the milling and dry lay several planks to ensure the product has no issues. See owner installer responsibility page 2. Do not open all the boxes and subsequently request replacement material.

Engineered Bamboo, just like wood flooring is harvested from a living plant. They are both cellulose based materials and hydroscopic in their structure. As a living plant, the cell walls expand when exposed to moisture to store additional moisture, and the cell wall would conversely shrink when moisture in the cell dropped. This is a well defined biomechanical reaction to changes in relative humidity and corresponding EMC. This is why both wood and bamboo expand and contract with changes in the environmental relative humidity, or exposure to moisture.

1. Establish Appropriate Climate Conditions: Teragren bamboo flooring must be installed over a vapor barrier or vapor retarding system.
2. Control Climate Conditions at Time of Acclimation: Acclimation should occur in normal living conditions at the middle of the normal relative humidity swing for the area. In areas where relative humidity falls below 35%, whole house humidification must be added to HVAC /Climate Control Systems, to prevent floor from becoming too dry.
3. Time Required for Acclimation: For proper acclimation, flooring must be delivered to the job site a minimum of 48 hours prior to installation. Evenly distribute unopened boxes in a dry, climate controlled

Relative Humidity - levels required to maintain moisture content of wood & bamboo

From - United States Department of Agriculture
Forest Products Laboratory
National Wood Flooring Association

Relative Humidity levels required to maintain below moisture content:

RH	5%	10%	15%	20%	25%	30%	35%	40%	45%	50%	55%	60%	65%	70%	75%	80%	85%	90%	95%	
°F																				
°C																				
30°	-1.1°	1.4	2.6	3.7	4.6	5.5	6.3	7.1	7.9	8.7	9.5	10.4	11.3	12.4	13.5	14.9	16.5	18.5	21.0	24.3
40°	4.4°	1.4	2.6	3.7	4.6	5.5	6.3	7.1	7.9	8.7	9.5	10.4	11.3	12.3	13.5	14.9	16.5	18.5	21.0	24.3
50°	10.0°	1.4	2.6	3.6	4.6	5.5	6.3	7.1	7.9	8.7	9.5	10.3	11.2	12.3	13.4	14.8	16.4	18.4	20.9	24.3
60°	15.6°	1.3	2.5	3.6	4.6	5.4	6.2	7.0	7.8	8.6	9.4	10.2	11.1	12.1	13.3	14.6	16.2	18.2	20.7	24.1
70°	21.1°	1.3	2.5	3.5	4.5	5.4	6.2	6.9	7.7	8.5	9.2	10.1	11.0	12.0	13.1	14.4	16.0	17.9	20.5	23.9
80°	26.7°	1.3	2.4	3.5	4.4	5.3	6.1	6.8	7.6	8.3	9.1	9.9	10.8	11.7	12.9	14.2	15.7	17.7	20.2	23.6
90°	32.2°	1.2	2.3	3.4	4.3	5.1	5.9	6.7	7.4	8.1	8.9	9.7	10.5	11.5	12.6	13.9	15.4	17.3	19.8	23.3
100°	37.8°	1.2	2.3	3.3	4.2	5.0	5.8	6.5	7.2	7.9	8.7	9.5	10.3	11.2	12.3	13.6	15.1	17.0	19.5	22.9
110°	43.3°	1.1	2.2	3.2	4.0	4.9	5.6	6.3	7.0	7.7	8.4	9.2	10.0	11.0	12.0	13.2	14.7	16.6	19.1	22.4
120°	48.9°	1.1	2.1	3.0	3.9	4.7	5.4	6.1	6.8	7.5	8.2	8.9	9.7	10.6	11.7	12.9	14.4	16.2	18.6	22.0

space. Leave a four inch space under the unopened boxes to ensure all boxes can acclimate to job site temperature. Do not store boxes on bare concrete, gypcrete or other Cementous surfaces, or stone, or tile surfaces.

After acclimation process it is important to maintain the 35 to 55% humidity range for the product to perform properly.

Excessive humidity can cause undue expansion in the plank, creating peaked edges, and distortion of the plank.

Low humidity can cause the top layer to experience significant shrinkage, resulting in dry-cupping of the surface layer of the plank. Additionally, splits and cracks can appear in the surface of the plank.

NOTE: A certain amount of humidity swing is considered to be normal (between 35 to 50% RH) and some tightness and gapping can occur in normal use.

To maintain proper relative humidity levels, above 35% and below 55% RH, use of the following equipment is recommended. Failure to maintain humidity range can result in damage to the bamboo floor.

A 50% swing in relative humidity produces and EMC change of approximately 10%. How that effects Wood and Bamboo flooring varies somewhat by species. However, this change in EMC will create a dimensional change in the material itself.

Teragren manufactures material to mimic what would be found in the middle of a 35–55% relative humidity environment (roughly 40% RH). Consequently, it is pre-acclimated to the green zone conditions found in the chart page 8.

Air conditioner (of proper size and in working order)
Dehumidifier (if required) to prevent relative humidity levels above 55%
Whole House Humidifier (of proper size and in working order) (if required) to maintain relative humidity levels above 35%.

IMPORTANT: Failure to properly acclimate or maintain a proper temperature and relative humidity with bamboo/ wood flooring may cause excessive expansion, shrinking, buckling, or splitting. Proper acclimation of the floor is the responsibility of the homeowner/installer.

MOISTURE METER CONVERSION FOR TERAGREN XCORA® STRAND WOVEN BAMBOO FLOORING ENGINEERED STRAND: *Essence & Neotera*

The following table has been carefully developed to be compatible with Teragren Xcora® strand bamboo flooring. Moisture readings will vary slightly depending on temperature, density, and color.

Expect accuracy to be with +/- 1.5 %.

The following meters have been calibrated to strand bamboo. The lab tests used strand bamboo acclimated

to 45%RH at 80° F to establish a base line. In this controlled acclimated environment the moisture content of Teragren’s Xcora® strand bamboo tested at 8.3% EMC.

Lignomat



Face Veneer/Wear Layer – Test Settings

- Ligno - Scanner SDM - Pin
- Ligno - DuoTec BW - Pin
- Ligno - VersaTec - Pin

Face Test Settings

Essence

- 20 - Savanna, Grasslands
- 21 - Open Range, Tundra, Prairie, Meadows

Core/Plywood – Test Settings

Essence - All

- 54 - Ligno - Scanner SDM - Pin Less (Setting ¼ Depth)
- 54 - Ligno - DuoTec BW - Pin Less (Setting ¼ Depth)
- 169 - Ligno - VersaTec - Pin Less (Setting ¼ Depth)

Teragren recommends the use of Lignomat meters for testing moisture content of Essence & Neotera. The pin settings for the face veneer/wear layer and ¼” pin less setting for the core. This provides the most accurate method of testing.

Radiant Heat

Essence and Neotera are not approved for use over radiant heat, both water & electric based systems.

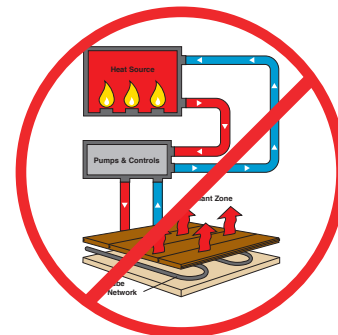

Below Grade Installation?

A concrete slab is considered below grade when any part of the slab is below ground level. For example, a basement with a walk out is considered below grade. A house cut into a hill is also considered to be below grade if it isn't properly graded to create a drainage swale on the lot.

Essence & Neotera are engineered products, and are suitable for below grade application, when conditions permit.

Solid bamboo flooring is not suitable for below grade installation.

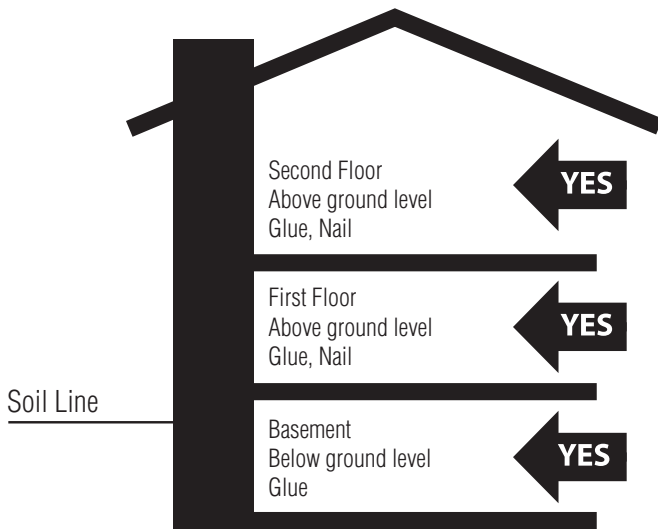

Sub floor Moisture Testing CONCRETE

Since wood & bamboo flooring is not compatible with wet conditions, Teragren Inc. does not warrant against moisture related issues or related damage under warranty. (See Teragren Maintenance & Warranty Guides). This is an industry standard, and manufacturers do not offer moisture warranties. However, moisture warranties are offered by various adhesive manufactures.

NOTE: Due to the porous nature of concrete, vapor emissions are subject to change over the lifetime of the installed floor. Slab moisture emissions are a common cause of damage to hardwood & bamboo floors. Due to the potential for concrete moisture emissions to increase/decrease over time, and the absence of moisture warranties for wood flooring, choosing an adhesive system that includes moisture abatement properties is prudent.

ADDITIONAL NOTE: Teragren Inc. makes no guarantees regarding the performance of any adhesive/vapor abatement system.

The installer is fully responsible for proper installation, and the moisture warranties are fully the responsibility of the adhesive moisture abatement system manufacturer chosen for the job.

NOTE: Hallmark 2 Luxury Vinyl Concrete Sealer is approved for use beneath underlayment pads, and can provide significant moisture protection under pad (see next page)

NWFA & Industry Standards

The NWFA (Industry standard) uses the following test methods to determine optimal conditions for installation and performance of a hardwood or bamboo floor. Some adhesive manufacturers offer systems that create a vapor barrier to protect the wood or bamboo flooring from moisture emissions coming up through the slab. Many adhesive manufacturers require the tests listed below to be performed prior to installation of the floor. Carefully read and follow the adhesive manufacturer's instructions.

CALCIUM CHLORIDE: ASTM F1869

Under ideal conditions, the slab should not be emitting more than 3 lbs. per 1,000 square feet per 24 hour period. Carefully follow the instructions in the test kit to ensure that you get accurate results.

NOTE: The slab emissions can vary based on soil humidity and room temperature. Consult adhesive manufacturer's directions for the moisture abatement system they recommend.

HUMIDITY PROBE & DIGITAL METER: ASTM F2170

Widely used in Europe, this test determines the amount of humidity in the slab. This is an effective way to determine a slab's potential for emitting moisture. Follow all meter manufacturer's guidelines for performing testing. Under ideal conditions, the slab readings should be 75% RH. CAUTION: Post Tension slabs require special care to avoid cutting cables in slab. Cutting post tension cables can cause serious structural damage and potential fatalities.

New concrete slabs require a minimum of 60 days drying time before covering them with a bamboo floor. The slab must be fully cured. Slab must be comprised of Portland-based mix with 2,500 PSI of compressive strength.

Sub floor Preparation CONCRETE

Sub floor tolerance for a flat surface is 3/16" within a 10' radius and 1/8" in a 6' radius. These are industry standards established by NWFA. Use a straight edge to determine if sub-floor requires grinding or filling.

NOTE: A quarter is approximately 1/16" thick and can be used as a basic thickness gauge, in conjunction with a straight edge. Grind high spots and fill low spots with adhesive manufacturer's recommended filler.

NOTE: Use the filler method recommended by the concrete sealer manufacturer.

CAUTION: ASBESTOS

State and Federal agencies have determined that asbestos is a respiratory carcinogen. Avoid sanding or scraping of old vinyl, linoleum and VCT as they may contain asbestos. Take proper precautions and contact an asbestos abatement company to remove any old vinyl or vinyl tile floors containing asbestos. Cut-back adhesive and other types of adhesives can also contain asbestos.

California Prop 65 Warning

Drilling, cutting, and grinding of concrete generates concrete dust, containing crystalline silica, a substance known to the State of California to cause cancer, birth defects, or other reproductive harm. Avoid inhaling concrete dust by wearing a dust mask or other safeguards for personal protection. CA HEALTH AND SAFETY CODE 14808-60-7: Wear appropriate NIOSH designated dust mask to reduce risk of dust inhalation. Wear proper eye protection and avoid prolonged contact with eyes and skin. In the event of eye irritation, flush with water for 15 minutes and seek medical attention!

Clean the Sub floor

After all prep work is completed, sweep and/or vacuum the sub floor. Dust and dirt can affect the adhesive or vapor barrier's ability to adhere to the slab.

Installing over Existing Floor Coverings

Concrete Perimeter-glued resilient vinyl, VCT and rubber tiles are not acceptable underlayment's and must be removed. Terrazzo, tile, and full spread glue-down vinyl's that are dry, structurally sound, and level (as described above) may be suitable as a sub floor for installation. Hallmark is not responsible for performance or suitability of existing flooring products that are not removed from concrete.

As indicated above, the surface must be sound, tight, and free of paint, oil, existing adhesives, wax, grease and dirt.

Terrazzo and ceramic tile must be sufficiently scuffed to assure adhesion. Portland based products must be used to comply with flatness requirements of 3/16" in a 10' radius or 1/8" in a 6' radius. See adhesive manufacturer's guidelines.

Existing vinyl, tile, or terrazzo are not considered to be vapor barriers

Hallmark 2 Two Part Epoxy Sealer – Floating Floors

When moisture content exceeds the limits authorized by underlayment pad, Hallmark 2 can be roller or trowel applied to increase the vapor resistance of slabs on or below grade.



For use when concrete subfloor moisture conditions do not meet standards of underlayment pad manufacturers. Hallmark 2 is applied after all adhesive removal is completed, all high spots have been ground down and before any leveling agent is applied. Any leveling agent must be Portland Based, read leveling agent manufacturing instructions for application over 2 part epoxy sealer.

NOTE: Hallmark 2 Not for use on radiant heat, lightweight concrete, concrete spall, or gypcrete.

Moisture barrier up to 18 lbs. on Calcium Chloride or 97% RH In-Situ Probe Test (using foam roller with max coverage of 140 sf per gallon.

OR

Moisture barrier up to 25 lbs. on Calcium Chloride or 100% RH In-Situ Probe Test (using #22 trowel with max coverage of 70 sf per gallon. Contains no water, solvents or VOC's.

Document all conditions of the slab, test results, and retain for your records.

FOR USE WITH:

Under 2mm underlayment pads to increase vapor abatement properties of the pad. See Hallmark Floors

DESCRIPTION: Hallmark 2 Sealer is a two component, epoxy reaction, resin-based sealer for flooring installation over high moisture subfloors. Hallmark 2 Sealer will lower moisture levels from a high moisture sub floor to an acceptable level, and will bridge minor cracks in the sub floor. Hallmark 2 Sealer spreads easily, and creates a dust free surface for your flooring installation. Hallmark 2 Sealer increases the bonding of applied primers, leveling compounds and/or adhesives.

PRE-INSTALLATION: A successful installation requires proper preparation of the sub floor. Read and understand all applicable guidelines for sub floor moisture, and layout of flooring. All flooring to be installed must meet the flooring requirements before the floor is installed.

SUB FLOOR: Do not apply Hallmark 2 Sealer onto a visibly damp or wet surface. Examine concrete sub floor for color, cleanliness, porosity and preexisting residues **PRIOR TO** installation. Check the concrete sub floor for any contaminants and follow installation guidelines for proper sub floor preparation. It must be sound, permanently dry, clean, free of old adhesive or adhesive residue as well as resistant to pressure and tension. Moisture content of all floors must be measured before installation.

SUB FLOOR PREPARATION: The condition of the sub floor will determine which type of mechanical treatment is required (e.g. wire brushing, sanding, grinding or shot blasting). Dust, paint, curing compounds, sealers, residual adhesives or other surface pollutants **MUST** be removed. Clean the surface with an industrial vacuum cleaner, tack or damp mop floor before application. Cracks and gaps must be treated prior to application.

MIXING OF COMPONENTS: Lid contains the hardener. Pierce all the way through the plastic disc in center of lid and the bottom of the lid using a long screwdriver or similar tool. Let the hardener flow into the lower part of the bucket. Remove the lid, and using a mixing paddle, mix both for at least 3 minutes using an electric drill with less than 300 rpm until an even color is reached. Mix slowly using the correct mixing paddle to avoid trapping air. Make sure to mix along wall and bottom of the container as well. Temperature of both components should be at least 50°F before mixing. Empty the entire contents of the pail onto floor immediately after mixing to prevent sealer from heating up and drying in the pail.

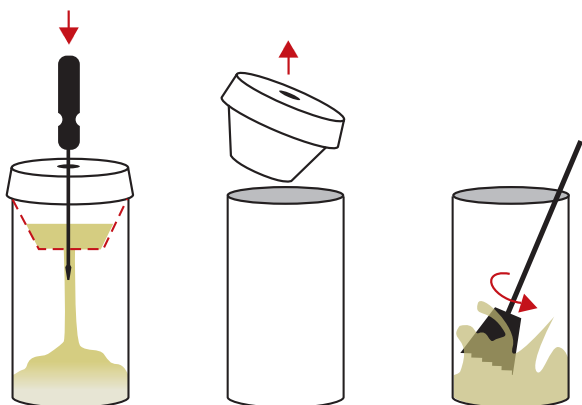

LIMITATIONS: When using product for purposes not listed in these instructions regarding Hallmark 2 Sealer, Teragren denies any and all responsibility for any problems and/or damages without prior written approval from Hallmark. Sealer will not prevent moisture damages from hydrostatic pressure, underground springs, compromised vapor barriers underneath the slab, damaged water pipes, sinks, icemakers, faulty plumbing, flooding, etc.

FEATURES: Seals slabs with any moisture content, contains no solvents, contains no VOC, contains no water, high solids content, ozone friendly, freeze/ thaw stable, contains no isocyanates.

BENEFITS: Low odor, high spread rate, spreads easily, excellent penetration of sub floor (higher temp and will shorten drying time). **CAUTION:** Watch pot life during installation.

LONG TERM FEATURES: Resistant against aging, moisture barrier up to 18lbs. or 97% RH w/roller, moisture barrier up to 25 lbs. or 100% RH w/trowel, suitable for radiant heat systems.

APPROVED SUB FLOORS: Concrete slabs, wet concrete slab up to 25lbs/24hrs/1,000SF

APPROVED APPLICATORS:
Foam Roller: up to 140 sf/gal #22 Trowel: 7/64" x 5/64" (up to 70 sf/gal)

1. Roller Application: Pour mixed Hallmark 2 in streams of about 4" wide and roll evenly with 1" foam roller on to concrete subfloor.



2. Trowel Application: Pour mixed Hallmark 2 in streams of 8" wide and pull the product evenly with across concrete subfloor with Hallmark #22 trowel.



DRYING TIME: 12-18 hours, completely cured after 7days

TEMPERATURE DURING INSTALLATION: 50°to 90°F

RELATIVE HUMIDITY DURING INSTALLATION: 30% to 80%

COLOR (HARDENER): Yellow

POT LIFE: Approx. 25 min at 70°F (21°C)

PH VALUE OF CONCRETE: Up to 14

WATER VAPOR TRANSMISSION (ASTM E-96):

0.012 grams/hour * m2

0.06 lbs/24 h * ft2 inHg

PERMEANCE(ASTM E-96):

0.026 grams/24h * m2 mmHg

0.04 grams/h * ft2 inHg

STORAGE: Above 14°F

Installing over Existing Floor Coverings

Concrete Perimeter-glued resilient vinyl, VCT, and rubber tiles can be acceptable substrates do not always need to be removed. If they are sound, smooth and flat they will accept an underlayment pad. If they are not sound, smooth and flat they must be removed.

Terrazzo, tile, can be a suitable substrate if sound, smooth and flat.

Hallmark 2 Sealer not approved over these conditions. barriers, and can still transmit unacceptable moisture levels to hardwood flooring. Existing hardwood flooring must be removed prior to the installation of a new wood floor on concrete.

Sub floor Moisture Testing WOOD

Remember: the top and bottom of the sub floor should vary no more than 2%. Wood substrates must have a moisture reading of no more than 12% when using Lingomat, Tramax, Delmhorst, or equivalent moisture meter, and be within 4% of the moisture content of the flooring to be installed.

Sub floor Preparation WOOD

Wood sub floors need to be well nailed or secured with screws. Nails should be ring shanks, and screws must be counter-sunk. The wood sub floor needs to be structurally sound (i.e. without loose boards, vinyl, or tiles). Sub floor tolerance for a flat surface is 3/16" within a 10' radius and 1/8" in a 6' radius. These are industry standards established by NWFA.

Engineered sub floor panels, must be ANSI-rated plywood, OSB (oriented strand board) of specified thickness to meet joist spacing specifications listed below, or sound solid lumber sub floor that is a minimum of 3/4" thick and dry.

1. For panel products sub flooring, check for loose panels and re-nail or screw down loose panels securely. Nails and screws must be countersunk.

2. Ensure that there is proper expansion space (1/8") between the panels. If panels are not tongue and groove and do not have sufficient expansion space, it may be necessary use a circular saw to create the specified space. Do not saw through joints on tongue and groove sub floors.

3. Check for delamination or damaged areas to sub floor and repair those areas as needed.

4. Make sure sub floor is free of debris before beginning installation.

5. Acceptable Panel Sub floors: Truss/joist spacing will determine the minimum acceptable thickness of the panel sub flooring.

a. Truss/joist spacing of 16" (406cm) o/c or less, the industry standard for single panel sub flooring is a minimum of 5/8" (19/32", 15.1mm) CD Exposure 1 plywood sub floor panels or 23/32" OSB Exposure 1 sub floor panels, 4' x 8' panels.

b. Truss/joist spacing of more than 16", up to 19.2" (488mm) o/c, the standard is a minimum 3/4" (23/32", 18.3mm) tongue and groove CD Exposure 1 Plywood 4' x 8' sheets glued and mechanically fastened.

c. Truss/joist spacing of more than 19.2" (488mm) o/c up to a maximum of 24" (610mm) requires a minimum 7/8" tongue and groove CD Exposure 1 plywood sub floor panels, 4' x 8' sheets, glued and mechanically fastened, or nominal 1" OSB Exposure 1 sub floor panels glued and mechanically fastened—or two layers of sub flooring.

JOIST CROSS-BRACING

A sub floor that is not thick enough to support the span of the joists will cause unacceptable sub floor deflection. An alternative to adding additional plywood on top of the sub floor would be to cross-brace between the joists. The cross-bracing would be done at the appropriate distance on center to meet specification and bring the deflection within proper tolerance.

Check with the joist or truss manufacturer to determine if cross- bracing is allowed with that system. Should it not be compatible with the joist or truss manufacturer, sheeting the sub floor with a second layer of CD or better grade plywood would then be the only option.

(See double layer sub floors section).

DIRECTION OF INSTALLATION IN RELATION TO JOIST DIRECTION.

The best application is at a 90° angle across the joists. This provides for best stability of the floor. As an alternative, the floor can be installed at a 45° angle to the joists. The floor cannot be installed in the same direction as the joists without installing an additional sheet of plywood on top of the existing wood sub floor.

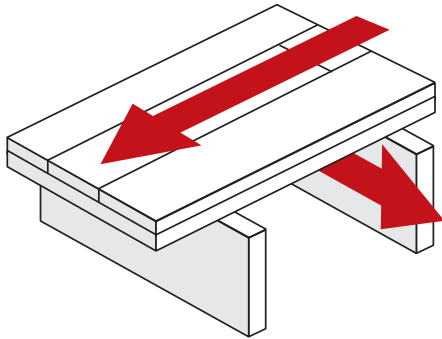

DOUBLE LAYER SUB FLOORS

When sub floor does not meet thickness standards for span between joists, a second layer of plywood or OSB is required to stiffen sub floor. See item C of previous section.

The second layer should consist of nominal ½" (15/32", 11.9mm) CD exposure 1 plywood sub floor panels, 4' x 8' sheets, depending on how much correction of deflection between joists is necessary.

The top layer of plywood should be offset by 2' from joints in first layer of sub floor, and installed in the opposite direction to the bottom sub floor panels. Glue top and bottom layer together with construction adhesive and screwing in to the truss/ joist system every twelve inches. Additionally, nail (ring shank) or staple layers together on a minimum 12" grid pattern.

SOLID BOARD/LUMBER SUBFLOORING

Solid Board Sub flooring should be ¾" x 5 ½" (1" x 6") group 1 dense softwoods (SYP, Doug Fir, Larch, etc.), #2 common, kiln-dried. Solid board sub flooring should consist of boards no wider than 6", installed on a 45° angle, with all board ends full bearing on the joists and fastened with a minimum 8d rosin-coated or ring-shanked nails, or equivalent.

Solid board sub flooring that is uneven at the edges should be repaired if/as needed and sheeted with ½" (15/32",

14mm) CD exposure 1 plywood sub floor panels, 4' x 8' sheets, and should be installed running cross-truss/joist. Glue top and bottom layer together with construction adhesive and screwing into the truss/ joist system every twelve inches. Additionally, nail (ring shank) or staple layers together on a minimum 12" grid pattern.

GENERAL INFORMATION: No fiberboard or particle board panels acceptable for nail down installation. Underlayment/industrial grade particle board sheeting over existing wooden sub floor is usually suitable for glue down applications. See adhesive manufacturer's specifications to ensure adhesive is suitable for use over underlayment/industrial particle board sheeting. Countersink all screws/ nails and sand any uneven edges smooth. High spots should be sanded smooth and low spots shimmed with plywood that is secured to the sub floor and sanded flat.

CEMENTITIOUS PATCH - WOOD SUB FLOOR: Do not use cement-based patch to correct any wooden sub floor problems in preparation for nail down. In the event of moisture, determine source, eliminate, and allow sub floor to dry. If sub-floor is less than above specified thickness, or sanded to thickness less than specified see the above standards for top sheeting. NOTE: Particle board sheeting of existing wood sub floor and Portland based leveling compounds are acceptable for glue-down or floating applications only (they are NOT suitable for nail-down applications).

EXISTING WOOD FLOOR – ON WOOD SUB FLOOR

When installing over an existing solid hardwood floor already attached to the wood sub floor, ensure that the existing floor is sound and firmly attached to sub floor. Install material at a 90° right angle or 45° angle (across grain) of existing hardwood floor.

NOTE: Do not install in the same direction as existing floor.

Do not install over wood flooring glued to concrete.

Getting Started

1. Select Installation Type

ABOVE GRADE WOOD SUB FLOOR

WOOD SUB FLOOR WITH CRAWL SPACE/ BASEMENT:

ON/ABOVE-GRADE CONCRETE: ABOVE GRADE

LIGHTWEIGHT CONCRETE GYPCRETE: Glue (see adhesive manufactures installation instructions for lightweight concrete/ gypcrete installations)

2. Cabinets & Appliances

FLOATING: Cabinets and built in appliances should never be installed on top of the floating bamboo floor. Floating floors require unhindered expansion space in all directions.

Bamboo flooring should be installed at the same time as carpet and after the following: finishing walls, cabinet installation, appliance installation, tile & counter top installation.

Standard refrigerators and kitchen oven/range are acceptable for placement on top of the wood floor. Use caution when moving appliances by using a proper furniture dolly, air sled, 1/8" Masonite with glossy side down, or plastic glides designed for movement of heavy appliances. Failure to follow these precautions will damage the floor.

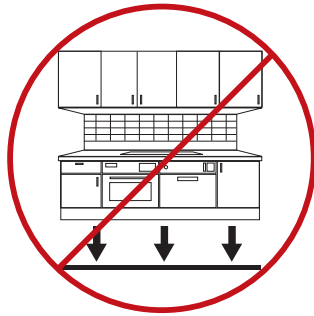

3. Undercut All Door Jambs/Moldings

Remove all shoe and base molding to ensure adequate expansion space. Use scrap piece of flooring to establish height of cut. Make allowances for adhesive or underlayment thickness when establishing height of cut.

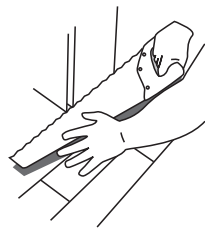

4. Visual Inspection of Boards

Visually inspect boards for any defects prior to installation. Verify that homeowner has seen product and approves proceeding with installation of the floor.

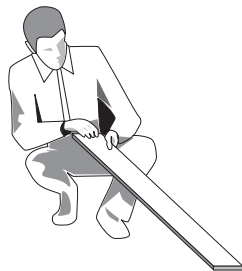

5. Blend Boards to Moldings

Before you get started, inspect the moldings. At beginning of installation, set aside those boards that best blend to the transition moldings on job.

6. Open Multiple Boxes

Always work from multiple boxes simultaneously and

blend the boards throughout the installation. This is especially important with mixed production dates. Teragren has very good color consistency, and mixed production dates are acceptable for installation. Working from multiple boxes/production dates helps achieve a good blend of color.

7. Select a Starter Wall

It is recommended to start the installation along an exterior wall. Check to make sure the wall is straight and square to the room. Start in corner with locking strip (groove end) facing the room.

8. Starting Line

Cut blocks to use against side and end walls to maintain 1/2" minimum expansion space. Use of adjustable spacers may be needed to help maintain a straight line.

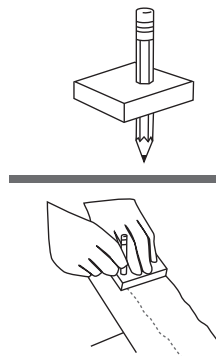

9. Irregular & Out-of-Square Walls

Scribe cut the first row to match variations in the wall. A scribe can be created by drilling a hole in a scrap piece of wood and inserting a pencil. The starting row can then be cut to compensate for an irregular wall or to help minimize the appearance of an out of square room by splitting the difference between the two walls.

9. Establishing End Joint Spacing

Applicable for all three methods of installation (glue-down, nail down). Each box contains random length boards. Use these boards as well as making some random cuts to establish a random pattern. Maintain a minimum distance/stagger between end joints of 4-8".

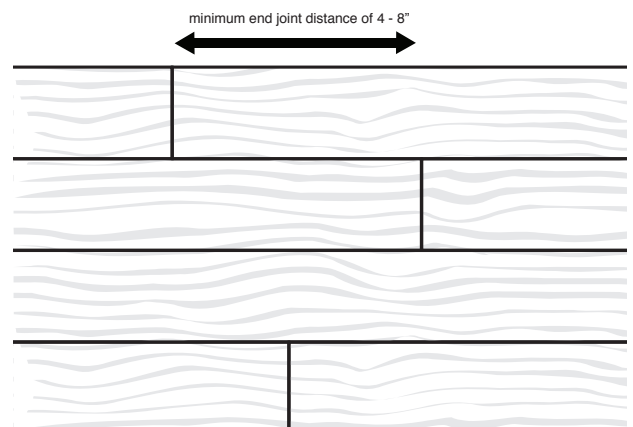

11. Change of Direction

GROOVE TO GROOVE, USING A SLIP TONGUE/WOOD SPLINE:

Slip-tongue/wood-spline can be fabricated using birch plywood, cut into strips on a table saw. Cut width to 5/16" wide to allow room for glue once inserted. The following thickness of Baltic Birch plywood should be used to fabricate wood spline for the following thickness of Hallmark Flooring:

3/8" = 3mm or 1/4"

1/2" = 4mm or 5/32"

9/16" = 4mm or 5/32"

5/8" = 5mm or 3/16"

3/4" = 6mm or 1/4"

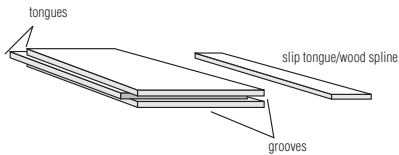

Note: Sand corners of spline with sanding block and 60 grit sandpaper to soften/round the edges (all four sides).

Installation Alert

Do not use rubber mallets or hammers on the finished edge of the floors. Do not kick, the floor into place. Mallets and hammers damage the finished edge and kicking can scratch the floor. Make sure mallet driven gun is not damaging the side of the board.

Use overlapping nylon tapping block for glue down. Use a flush edge nylon tapping block for nail down and for floating installations.

GLUE DOWN INSTALLATION

GENERAL INFORMATION

NOTE: Follow instructions 1-11 and all directions listed below.

Installation Tools GLUE DOWN

Tape measure, pencil, chalk line, table saw, cut-off saw, jamb saw, tapping block, pull bar, spacers, ratcheting floor straps, hammer, safety glasses, hearing protection, utility knife, specified notched trowel, wall spacers, straight edge, broom, speedy square, hardwood floor cleaner, and shop vacuum.

12 GD. Remove Tongue & Lead with Groove

Cut off tongue on very first row to be installed and lead with the groove. This enables the tongue to be partially inserted into the groove before coming into contact with the adhesive

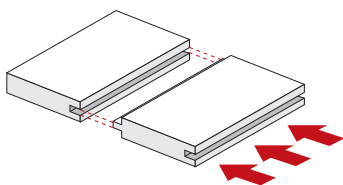

13 GD. Starter Rows

Measure the equivalent of four to five rows, mark sub floor at both ends of run and snap a chalk line. Spread adhesive to chalk line. Repeat this process on all subsequent rows of material throughout the balance of installation.

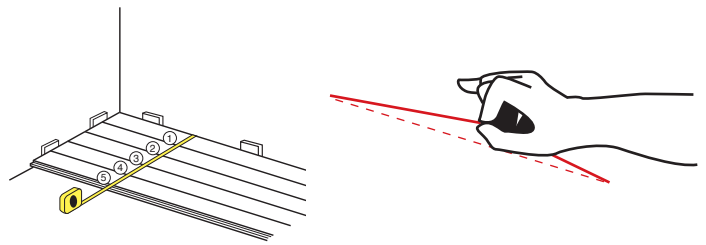

NOTE: It may be necessary to use painter's tape for delicate surfaces during the install to keep planks together, while glue dries. Remove delicate surface painter's tape within 24 hours of application.

14 GD. Strap Starter Rows

Once starter rows are installed up to chalk line/edge of adhesive bed, strap across the grain. Allow adhesive to set up long enough to have a firm hold. Use the flat side of the trowel to flatten any adhesive at edge of the leading board. Once the boards are firmly seated, proceed to work across the floor.

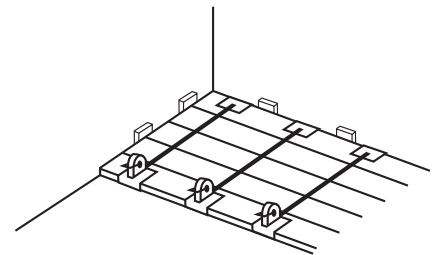

CAUTION: Do not let boards open or drift off straight line.

15 GD. Check Straight Lines

Run string along joint lines to check in you are wandering off line and use caution to keep all end and side joints closed. The edge of a 6' level or straight edge along the leading rows can also help determine the maintenance of a straight line.

16 GD. Trim Last Row

Cut the last row and snug into place using a pull tool. Face nail with 18-gauge nails at edge of last row.

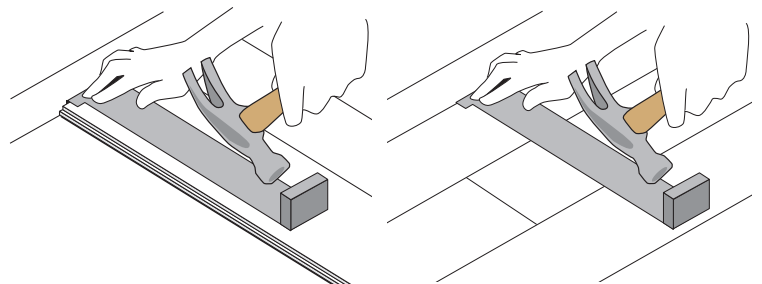

17 GD. Install Transition Moldings

Install moldings using urethane glue or high-quality adhesive. It may be necessary to place weight on edge to ensure molding level is flush with flooring.

NAIL DOWN INSTALLATION

GENERAL INFORMATION

NOTE: Follow instructions 1-11 and all directions listed below.

Installation Tools

NAIL DOWN

Tape measure, pencil, chalk line, table saw, cut-off saw, jamb saw, tapping block, pull bar, spacers, hammer, safety glasses, hearing protection, utility knife, wall spacers, straight edge, broom, speedy square, hardwood floor cleaner, pin/finish nails, air compressor, and shop vacuum.

SET UP AND USE OF PNEUMATIC CLEAT-NAILERS

Minor squeaks and pops are normal in nail down installations. This is not considered to be a manufacturing defect and is an accepted fact by the industry and the National Wood Flooring Association. Teragren Bamboo's Maintenance and Warranty Guide does not cover squeaking or popping of floor.

To minimize these issues make sure that subfloor thickness, ns joist spacing are correct and the subfloor is sound. Repair any structural issues with subfloor prior to installation of the floor

Gun adjusts to nail 12mm to 14mm thickness.

Make sure your nail/cleat gun is properly adjusted to put the fastener in the pocket (where the back of the tongue and the side of the plank meet). Pay close attention to placement and if any damage is being done to the edge of the plank by the nail gun.

Adjust the air pressure up or down until setting seats the cleat into pocket.

Too little air pressure leads to the cleat sitting too high, allowing excess movement and rubbing against the edges of the plank above the tongue and groove. Too much air pressure will seat the cleat too low and distort the tongue of the plank.

Improper adjustment of gun can lead to the tongue being placed outside of the pocket, potentially breaking the tongue, splitting the veneer line in the core, or leaving a bump at the edge of the plank where the fastener is placed.

PROPER CLEAT PLACEMENT

AIR PRESSURE SETTINGS

Air Pressure Settings

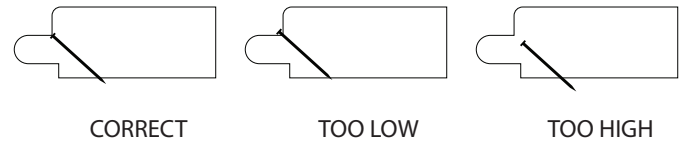

Approved Cleat/Nail Systems

POWER NAIL PNEUMATIC MODEL 50P
Flex 18 gauge, Cleat 1 ½"

Use 12 oz. rubber hammer to activate gun.
Gun adjusts to nail 12mm to 14mm thickness

POWER NAIL PNEUMATIC MODEL 50F
Flex 18 gauge, Cleat 1 ½"

Use 12 oz. trigger activated.
Gun adjusts to nail 12mm to 14mm thickness

POWER NAIL AIR DRIVEN MODEL 200
20-gauge/e-cleat 1 ½"

Use 12-oz. rubber hammer to activate gun.

PRIMATECH PNEUMATIC MODEL Q550R
Adjustable base plate and surface rollers
18 gauge, L cleat x 1 ½"

Use 12 oz. rubber hammer to activate gun.
Adjusts to nail 3/8", ½", 9/16", & 5/8"

Do not use the following systems for nailing down Teragren products.

Staple Systems

15 Gauge Cleat Systems

12 ND. Underlayment

RECOMMENDED UNDERLAYMENTS

15 to 30 lb. roofing felt when doing a nail-down installation. Staple in place and then proceed to install the floor.

Aquabar "B" Hardwood Floor & Tile Underlayment. Staple in place and then proceed to install the floor.

Allglobe –Silicone Vapor Shield. Staple in place and then proceed to install the floor.

CAUTION:

Red Rosin or craft paper is not an accepted underlayment. Foam underlayment pads are not acceptable for nail down. Elimination of underlayment's in favor of running beads of construction adhesive to increase the holding power to the sub-floor has some risks. Underlayment's have always acted as a vapor inhibitor.

Without the underlayment, the floor is subject to cupping and crowning from moisture intrusion from the sub floor.

13 ND. Starter Rows

Nail-down method requires that installation be done by leading with the tongue.

When starting at the wall, trim groove off the back of the boards being used for the starting row. Face nail the back edge of the board with 18-gauge nails, then blind nail into the pocket above the tongue with one of the above approved cleat/nail staple system.

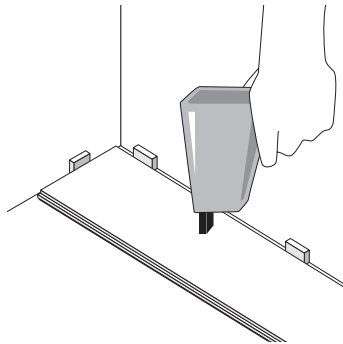

Face nailing is an industry accepted practice, face nailing the boards as far back as possible can help hide the face nailing under the base and quarter round/base shoe. It may be necessary to blind nail the tongues of the starter boards to eliminate any surface nail holes until far enough from the wall to use floor nailer.

14 ND. Nail/Cleat Spacing

Nail/cleat spacing needs to be 4" to 6" apart and within 2" of board ends. Installer should be standing directly on top of the board being nailed down. This ensures the bottom of the plank is firmly seated on the sub floor. Check regularly to ensure the plank is snug to the sub floor. Any gap between the bottom of the plank and the sub floor is a source for squeaking.

Warning: Nailing too close to end could fracture the corner of the plank.

15 ND. Check Straight Line

After three rows of flooring have been installed, take a six-foot level and check the leading edge to be sure floor is on a straight line. Lay the level on its back and glide bottom edge along the tongue. Failure to stay on a straight line will cause irregular gaps in floor on sides and ends.

16 ND. Trim & Face Nail End Rows

Cut the last row and snug into place using a pull tool. Face nail the remaining rows with 18 gauge nails. It will be necessary to face nail the remaining rows when the blind nail gun is too close to the wall to fasten down the planks.

NAIL DOWN - GLUE ASSIST

GENERAL INFORMATION NOTE:

The following is an addendum to the nail down section. A great deal of controversy surrounds the practice of glue assist/nail down. The underlying risk in this method is that the vapor barrier sheet is now missing from the surface of the subfloor.

The vapor barrier sheet can act as a safeguard against seasonal changes in humidity in a basement or crawlspace, and not using a vapor barrier sheet carries additional risk that will require more diligence by the homeowner. Stringent control of humidity, moisture in basements, and crawl spaces must therefore be exercised.

A moisture imbalance in the bottom of the plank, due to a lack of moisture control, combined with drier air in the room above can cause moisture related damage to the floor.

Hallmark Floors, like the entire wood flooring industry has no warranty against moisture related issues with the floor.

1 ND/GA. Subfloor Deflection.

The primary cause of squeaking floors is related to subfloor deflection/subfloor movement, between the joists. Even if the subfloor is the proper thickness to meet specifications, this can still be an issue due to the subfloor not having enough tensile strength to perform to industry specifications.

2ND/GA. Felt or Paper Barriers

Barriers of any kind cannot be used for this application method.

Glue assist cannot be applied to the surface of a moisture membrane such as Aquabar or 15lb roofing felt. Unfinished basements or uncontrolled crawl spaces may expose the subfloor and the plank itself to elevated moisture contents that will cause excessive expansion of the floor. Finished basements and enclosed crawl spaces with proper humidity control are required for glue assist.

3ND/GA. Subfloor Moisture - CAUTION

Moisture intrusion or exposure to moisture is not covered under warranty.

4ND/GA. Glue Type & Application Method

Glue must be a high quality urethane construction adhesive. The glue should be applied in a serpentine pattern on the bottom of the plank, as shown in diagram to right.

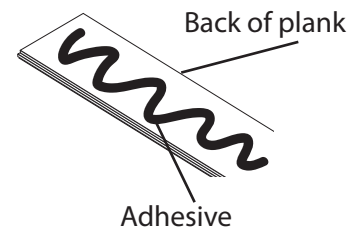

NOTE: Glue assist applications will not perform properly when applied to the surface of a vapor barrier such as Aquabar or 15lb roofing felt. Glue assist will only work on the wood subfloor itself without a vapor barrier applied.

FLOATING INSTALLATION

GENERAL INFORMATION

SPECIAL NOTE: Teragren's Tongue & Groove flooring is not approved for floating floor applications.

COORDINATING ACCESSORIES

STAIR NOSE

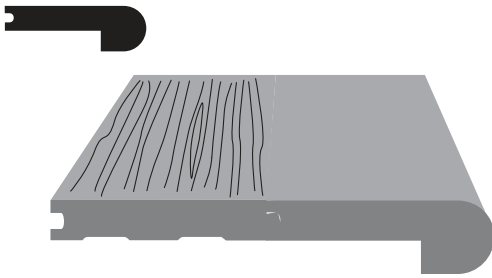

CLAMSHELL REDUCER

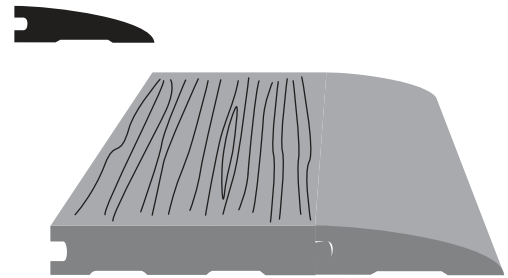

BABY THRESHOLD

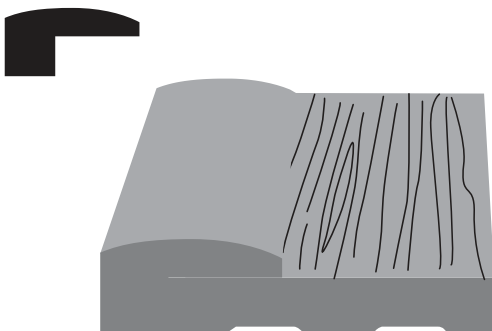

T - MOLD

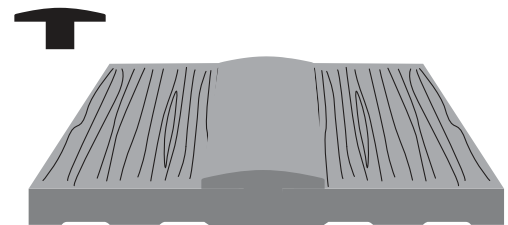



FINE BAMBOO FLOORING, PANELS & VENEER

Teragren Inc.
Installation Instructions Pre-finished Engineered Bamboo - Tongue & Groove
2020.v1